

Narrow Band Module Evaluation Kit

Narrow Band Evaluation Kit (NBEK) can be used to evaluate all Narrow Band Multi-channel and Single frequency DIL version modules. Radio modules can be assessed for their suitability in terms of wireless operating range, functionality, reliability and robustness in a multi-user environment with several other modules on different channels. Built in Control44, I1200 modes allow user to evaluate the performance of Radiometrix narrow band modules in a typical Remote Control and data transmission application in an industrial environment.

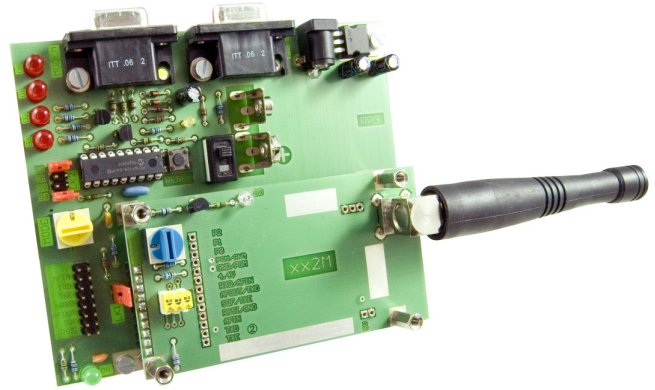

Figure 1: Main controller board + xx2M series carrier board

Features

- RF module range testing
- Noise and interference identification
- Antenna type evaluation
- Analogue and digital data transmission
- 4 Data channel remote control
- 1200 baud dumb modem
- Setup is simple as Plug-and-Play
- RS232 Serial port interface for frequency/channel configuration
- RS232 Serial port interface for 1200 baud dumb modem
- Access to internal diagnostic/Test modes using HyperTerminal
- Access to each data/control pins for external interface or testing

Contents

- 2 Controller board
- 2 Carrier boards according to modules ordered separately
 - BiM/SMX series (BiM1, NiM2, BiM2A, BiM3B, SMX1 and SMX2) carrier board
 - xx2M series (TX1M/RX1M, TX2M/RX2M, TR1M and TR2M) carrier board
 - LM series (LMT1/LMR1 and LMT2/LMR2) carrier board
 - TLC2H /RLC2H and HVR2 carrier board
 - SIL series modules (e.g. HX1, NTX2 / NRX2, TX3H/RX3A etc.) carrier board
 - USX / UHX carrier boards
- 1 Pair of Radiometrix multichannel or single frequency TX/RX or transceivers (ordered separately)
- 2 9V alkaline battery (PP3)
- 10 Jumpers
- 1 Narrow Band Evaluation Kit manual
- 1 Data sheet of Radio module ordered
- 2 1/4 wavelength monopole antenna with BNC connector for 433MHz operation
- 2 Helical antennas with BNC connector for 151MHz / 173MHz (optional)

Configuring the Narrow Band Multi-channel Evaluation Kit

One of the Evaluation Kit should be assigned as transmitter and other as receiver.

Jumpers on the main controller board

LK1	Connects R1=2.2kΩ across TXD and GND pins R18=1.5kΩ in series with TXD.
Inserted	3V CMOS Data Input to Transmitter. Only being fitted for 3V _{PK-PK} input only modules (BiM1, NiM2, TX1, NTX2 etc)
Removed	5V CMOS Data Input to Transmitter
LK2	Jumper inserted: 0V (logic '0') and LED ON; Jumper removed: 5V (logic '1')
D0	Selects Data Bit0 value during Control44 encoder mode
D1	Selects Data Bit1 value during Control44 encoder mode
D2	Selects Data Bit2 value during Control44 encoder mode
D3	Selects Data Bit3 value during Control44 encoder mode

Jumpers on the carrier board:

XX2M series

	Slide yellow coloured switches to ON position marked by arrow for TX1M, TX2M Remove for RX1M, RX2M, TR2B, TR2M
LK3	TXE from controller routed to TXE pin on TX2M (SQF pin on RX2M, TR2M)
LK4	TXD from controller routed to TXD pin on TX2M, (AFOUT pin on RX2M, TR2M)
LK5	AFIN from controller routed to AFIN pin on TX2M (RXD pin on R2M, TR2M)

Switches

MODE (yellow)	H=VDD L=0V (inverted logic) M3 M2 M1 M0	
0	HHHH	Receiver ON
1	HHHL	Un-modulated Transmission for testing carrier frequency, power, spuri
2	HHLH	250Hz (500bps) square wave Modulated Transmission
3	HHLL	1250Hz (2.5kbps) square wave Modulated Transmission
4	HLHH	Pseudorandom NRZ stream modulated Transmission
5	HLHL	Transmitter and Receiver turned ON and OFF periodically at 100ms interval
6	HLLH	RESERVED for future use
7	HLLL	RESERVED for future use
8	LHHH	Continuous Control44 Transmission of Address=0 and Data=D3, D2, D1, D0
9	LHHL	Control44 Transmission of Address=0 and Data=D3, D2, D1, D0 If either Data is changed or RESET (Trigger) switch is pressed.
A	LHLH	Control44 Reception with Momentary Output. (paired with Mode 8)
B	LHLL	Control44 Reception with Latched Output. (paired with Mode 9)
C	LLHH	Transmits CTR44 Test Packet, Receive Echoed Packet (Radar Mode – Master)
D	LLHL	Receive CTR44 Test Packet, Re-transmit it back to Sender (Echo Mode – Slave)
E	LLLH	I1200 type 1200 baud Dumb Modem for bit balanced serial data transmission
F	LLLL	RESERVED for future use

Notes:

1. Mode C, D require Transceiver
2. In Mode C, a test packet is transmitted, then the unit switches to Receive mode for 100ms before repeating.
3. Data sequence of 8 (D3=L, D2=H, D1=H, D0=H), 4, 2, 1 (D3=H, D2=H, D1=H, D0=L) is cycled through with each transmission.
4. In Mode D, the unit idles in Receive mode. When a valid CTR44 burst is received the unit keys up the Transmitter and re-transmits this CTR44 burst back to sender in Mode C.
5. The 'modem' mentioned (Mode E) is a 1200 baud RS232 semi-intelligent unit (Transmit keyed when valid serial data is present, so no separate TX control needed. Coding in the datastream also permits the receiver to ignore noise and only output valid serial data). This is a half duplex unit, so collisions between transmitted and received packets must be dealt with by the user.

CHANNEL (blue)	xx2M, SMX H=4V, L=0V Hex Switch	LM Series Units H=3V, L=0V Hex Switch	TLC/RLC/HVR H=3.5V, L=0V Hex Complement Switch
0	P2=H, P1=H, P0=H	P3=H P2=H, P1=H, P0=H	P3=L, P2=L, P1=L, P0=L
1	P2=H, P1=H, P0=L	P3=H, P2=H, P1=H, P0=L	P3=L, P2=L, P1=L, P0=H
2	P2=H, P1=L, P0=H	P3=H, P2=H, P1=L, P0=H	P3=L, P2=L, P1=H, P0=L
.....		
7	P2=L, P1=L, P0=L	P3=H, P2=L, P1=L, P0=L	P3=L, P2=H, P1=H, P0=H
8	Not in Use (Appears as Channel 0)	P3=L, P2=H, P1=H, P0=H	P3=H, P2=L, P1=L, P0=L
.....			
E (14)	Not in Use (Appears as Channel 6)	P3=L, P2=L, P2=L, P0=H	P3=H, P2=H, P1=H, P0=L
F (15)	Not in Use (Appears as Channel 7)	P3=L, P2=L, P1=L, P0=L	P3=H, P2=H, P1=H, P0=H

Note: channel switch to be set to 0 (LMR, LMT) or F (RLC, TLC, HVR) when serial (RS232) programming the unit, as 'P0' is also 'serial program in'.

User Test Points

Pin	Description
5V	5V, 1A Low Dropout Voltage Regulator Output
AFIN	Transmit Input for 1V _{pk-pk} Audio Frequency (Analogue) Signal using TX1M, TX2M, TR2M Set to MODE 1, to feed external Analogue Signal
TXD	Transmit Input for Digital (Binary) Data driven by onboard microcontroller Set to MODE 1, to feed external 5V CMOS level Digital Data
TXE	Active Low Transmit Enable driven by onboard microcontroller
RXD	Received (Digital) Data Output from Radio Module Open Collector output from module pulled up to 5V using R4=10kΩ
AFOUT	Audio Frequency (Demodulated Buffered Analogue) Signal
SQF	Active Low Squelch Function when RF Carrier is not present Open Collector output pulled up to 5V using R1=22kΩ on RX1M, RX2M, TR2M Carrier Board Connected to Q5 (NPN transistor) via R4=330kΩ base resistor to turn on Carrier Detect LED.
RSSI	Received Signal Strength Indicator

Visual Indicators

LED	Colour	Description
D0	Red	Data Bit0 output indicator during Control44 decoder mode
D1	Red	Data Bit1 output indicator during Control44 decoder mode
D2	Red	Data Bit2 output indicator during Control44 decoder mode
D3	Red	Data Bit3 output indicator during Control44 decoder mode
STATUS	Bright Yellow	STATUS indicator – Transmitter Active or Valid Data received
ON	Green	Evaluation Kit powered with correct polarity power supply
CD	Bright Orange	Carrier Detect indicator for RX1M, RX2M or TR2M derived from SQF output

Connectors

Pin	Description
DC socket	2.1mm power socket; when a power supply jack is inserted, a mechanical switch disconnects the battery negative
PROG	Connect to COM port of a PC using straight DB9M-DB9F serial cable to configure the channel and frequency of a multichannel module Hyper Terminal setting: 2400 baud, none parity, 8 data bits, 1 stop bit, none flow control
MODEM	Connect to COM port of a PC using straight DB9M-DB9F serial cable to evaluate serial data transmission through a radio module using onboard 1200 baud dumb modem. Hyper Terminal setting: 1200 baud, none parity, 8 data bits, 1 stop bit, none flow control
PP3 SNAP	8.4V NiMH or 9V Alkaline PP3 type battery
SIL socket	Appropriate radio module carrier board is inserted into the socket and secured with 4 short spacers

Note: The carrier board should always be firmly bolted down to the main controller board mounting studs at all four corners, or the grounding of the carrier board will be compromised. This is especially important when high power transmitters are used with the aerial connected directly onto the BNC. In this case, any mismatch will cause significant ground currents to flow.

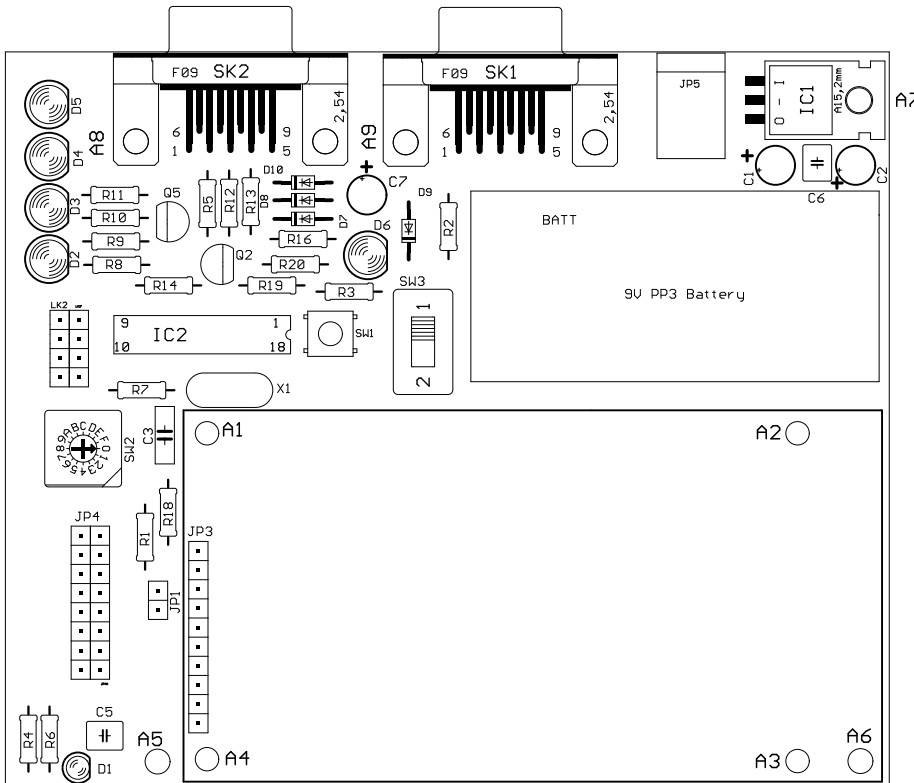

Figure 2: Main controller board component layout

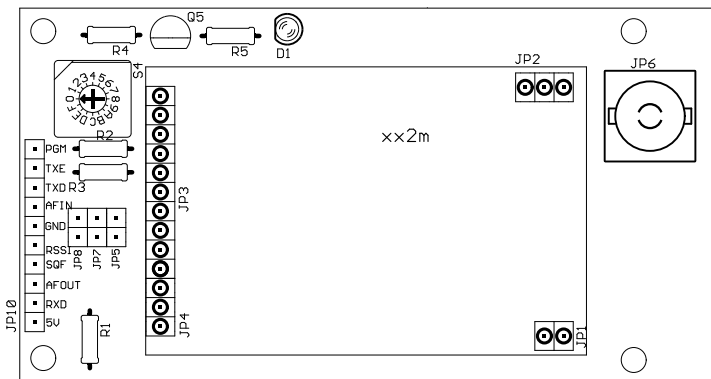

Figure 3: xx2M series carrier board

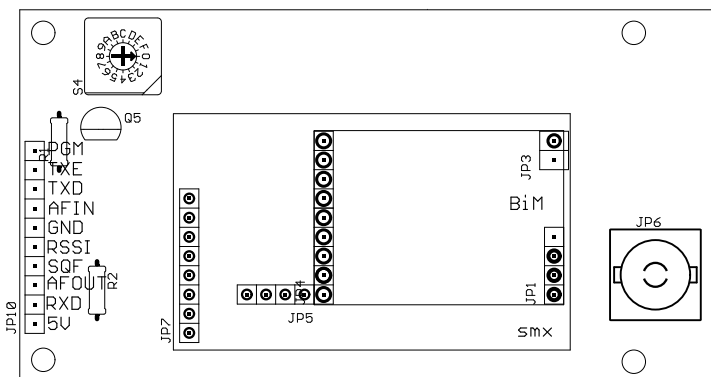

Figure 4: BiM / SMX series carrier board

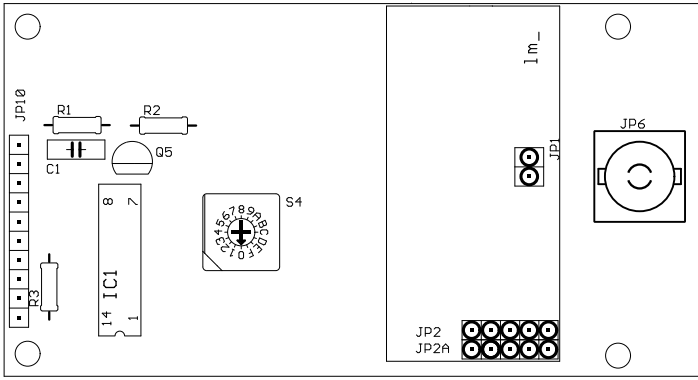

Figure 5: LM series carrier board

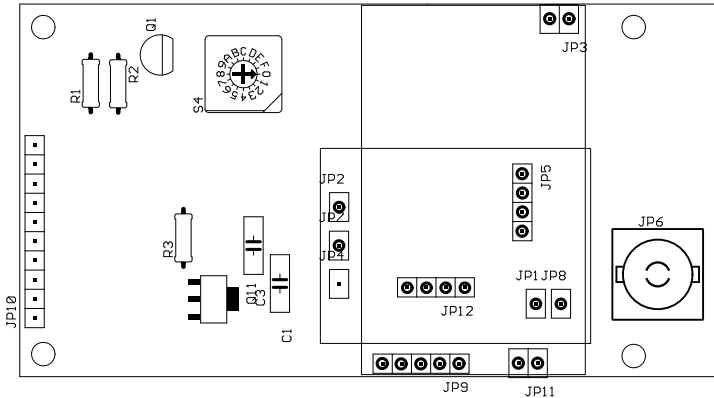

Figure 6: TLC2H/RLC2H and HVR2 carrier board

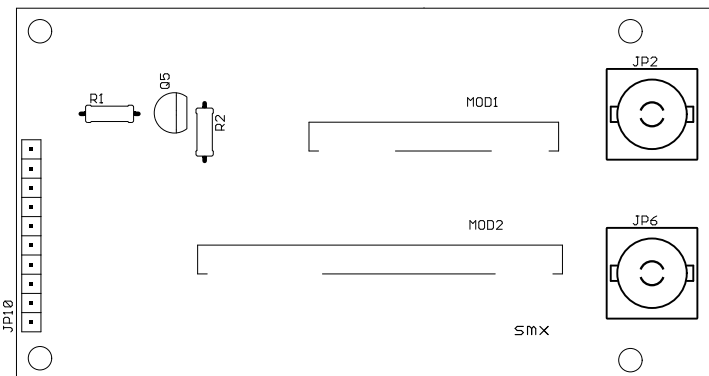

Figure 7: SIL series module carrier board

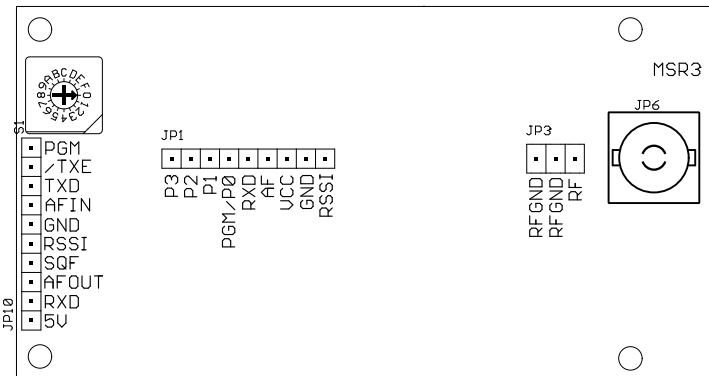

Figure 8: MSR or COR series module carrier board

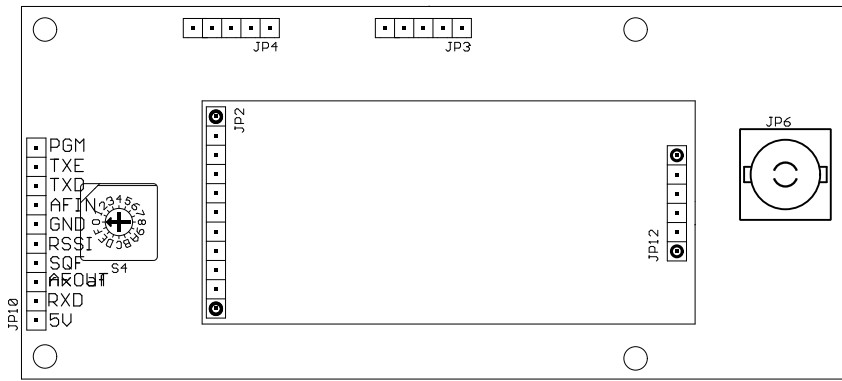

Figure 8: UHX1 module carrier board

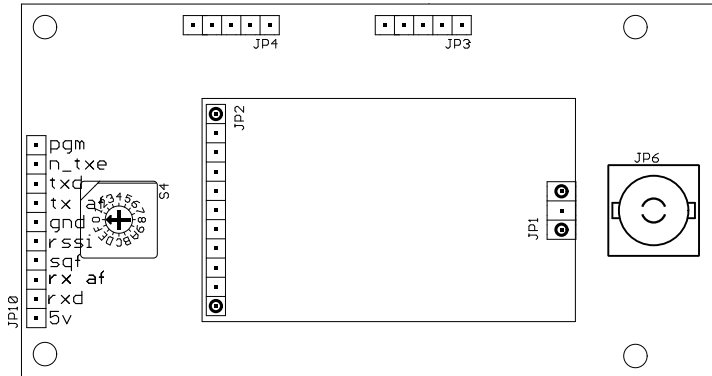
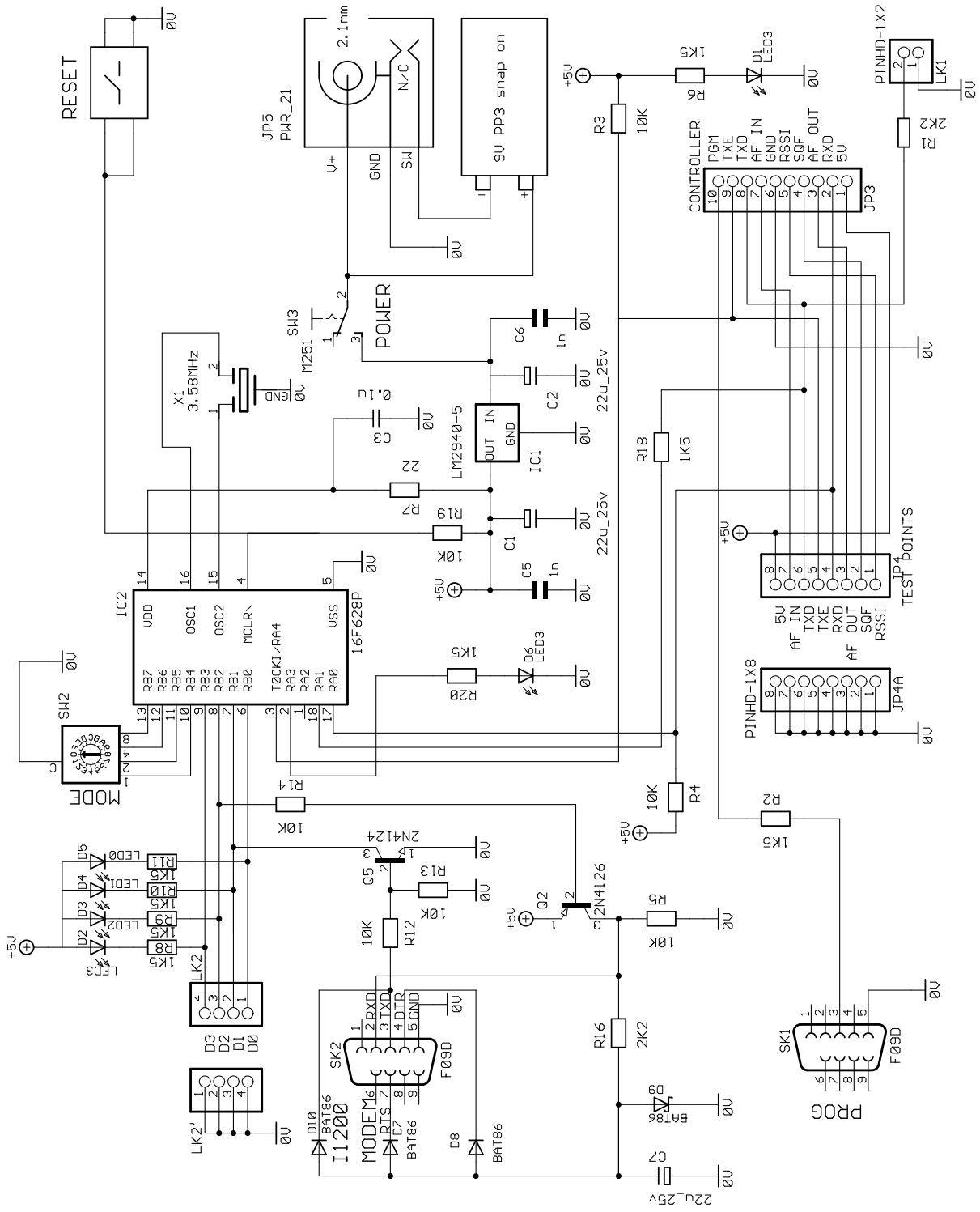

Figure 9: USX2 module carrier board



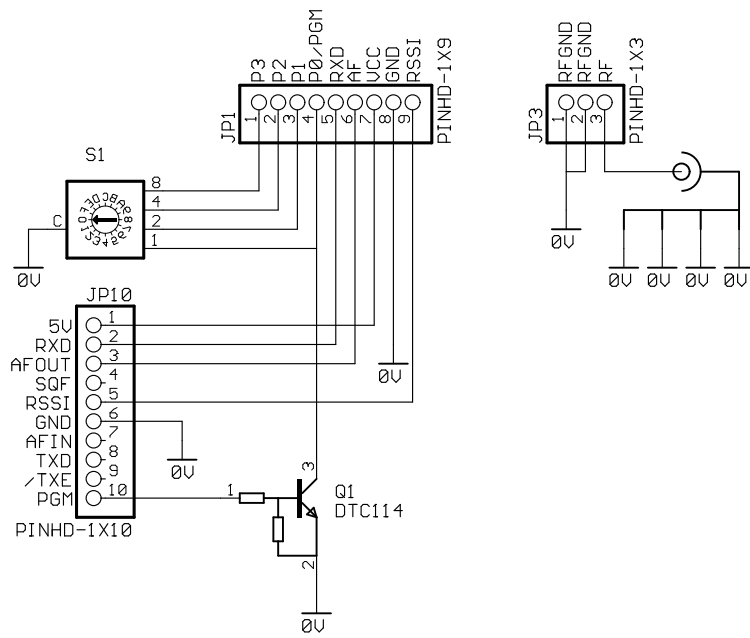

Figure 10: Schematics of main controller board

Narrow band Eval Kit controller IC

The NBEK controller IC can also be ordered separately with equal number of radio modules.

NBEK-000-DIL

Package type: 18-Lead Plastic Dual In-line
(300 mil)

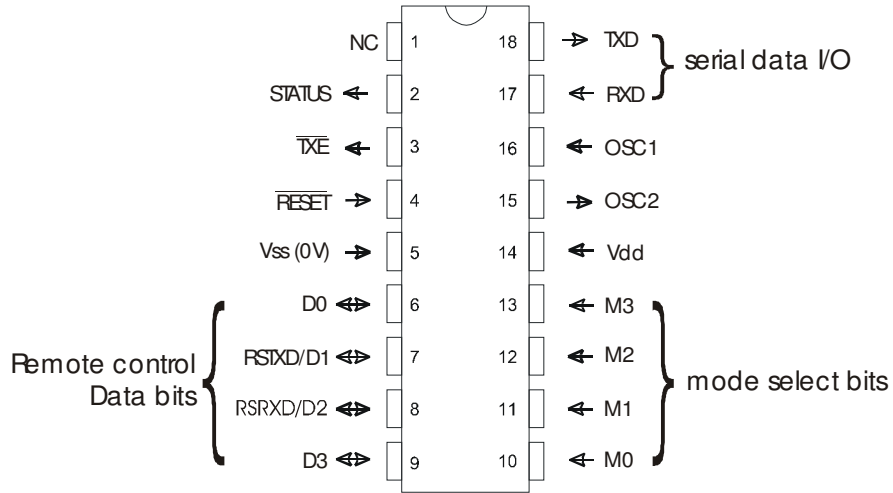

Figure 11: NBEK-000-DIL pinouts

Ordering Information (IC):

NBEK-000-SS - Shrink Small Outline

NBEK-000-SO - Small Outline

NBEK-000-DIL - Plastic Dual In Package

Radiometrix Ltd

**Hartcran House
231 Kenton Lane
Harrow, Middlesex
HA3 8RP
ENGLAND**

Tel: +44 (0) 20 8909 9595

Fax: +44 (0) 20 8909 2233

sales@radiometrix.com

www.radiometrix.com

Copyright notice

This product data sheet is the original work and copyrighted property of Radiometrix Ltd. Reproduction in whole or in part must give clear acknowledgement to the copyright owner.

Limitation of liability

The information furnished by Radiometrix Ltd is believed to be accurate and reliable. Radiometrix Ltd reserves the right to make changes or improvements in the design, specification or manufacture of its subassembly products without notice. Radiometrix Ltd does not assume any liability arising from the application or use of any product or circuit described herein, nor for any infringements of patents or other rights of third parties which may result from the use of its products. This data sheet neither states nor implies warranty of any kind, including fitness for any particular application. These radio devices may be subject to radio interference and may not function as intended if interference is present. We do NOT recommend their use for life critical applications.

The Intrastat commodity code for all our modules is: 8542 6000

R&TTE Directive

After 7 April 2001 the manufacturer can only place finished product on the market under the provisions of the R&TTE Directive. Equipment within the scope of the R&TTE Directive may demonstrate compliance to the essential requirements specified in Article 3 of the Directive, as appropriate to the particular equipment.

Further details are available on The Office of Communications (Ofcom) web site:

<http://www.ofcom.org.uk/>

Information Requests

Ofcom

Riverside House

2a Southwark Bridge Road

London SE1 9HA

Tel: +44 (0)300 123 3333 or 020 7981 3040

Fax: +44 (0)20 7981 3333

information.requests@ofcom.org.uk

European Communications Office (ECO)

Peblingehus

Nansensgade 19

DK 1366 Copenhagen

Tel. +45 33896300

Fax +45 33896330

ero@ero.dk

www.ero.dk
